

**Double Wing PLANE Line RC5 Burglar Proof Steel Door**

**Plane Optic  
Burglar Proof**

**RC5**

**in accordance with DIN EN 1627**

* Noise Control	up to $R_{W,P}$ 46 dB	in accordance with DIN EN ISO 10140-2
* Shot Inhibiting	up to FB6	in accordance with DIN EN 1522
* Air Tight	Class. 4	in accordance with DIN EN 1026
* Rain and Fire Water Tight	Class. 6A	in accordance with DIN EN 1027
* Wind tight	Class. C5	in accordance with DIN EN 12211
* Pressure resistant	up to 5 kPa	
* Explosion protection	up to zone 1/21	in acc. with DIN EN 1127-1 or ATEX 94/9/EG
* Stainless steel		

**Range of Dimensions:**                      **Width from 625 mm to 1500 mm**  
**Height from 1750 mm to 3000 mm**

(\* special options see back of page)

**Technical specification and text for invitation to tender**

<b>Product:</b>	<b>PL-2 double wing security steel door brand Buchele in accordance with DIN EN 1627</b>
<b>Door Type:</b>	<b>PLANE Line PL 2 BASIC</b>
<b>Burglar Proof:</b>	<b>RC 5</b>
<b>Dimensions:</b>	<b>.... x .... mm</b>
<b>Door Leaf:</b>	Double walled, level 84 mm thick steel door leaf without hinge embossing, three sides folded with thick rebate without bottom stop. Special insulating inserts completely laid in and glued. Safety bolt screwed in door leaf fold.
<b>Sill:</b>	Floor bracket as separation bar. Surface galvanized and welded to the frame.
<b>Frame:</b>	3-sided circumferential folded corner frame with high-quality multi-chamber sealing profile adjustable fixed in the three sided groove.
<b>Hinges:</b>	Threepart height-adjustable construction hinges with hinge pin retention and ball-bearing spacer ring for smooth door movement.
<b>Fitting RC5:</b>	6-point safety locking system with latch lever function in accordance with DIN EN 12209 (prepared for installation of a profile cylinder lock provided by customer). Special safety door handle set firmly installed turnable aluminium F1 in U-shape with square protective plate. <b>Inactive door leaf</b> with espagnolette bolt lock in the central rebate profile.

**Type PLANE Line PL 2 PREMIUM**

<b>Frame:</b>	Three sided circumferential folded PLANE Line special corner frame for flush mounted optics on hinge side. High-quality multi-chamber sealing profile adjustable fixed in the three sided groove.
---------------	---

**Hinges:** Object hinges type VB-3D 160 adjustable in three dimensions. Reception element with internal positioned slide bearings for smooth door movement.

**Type PLANE Line PL 2 SUPERIOR**

**Frame:** Three sided circumferential folded PLANE Line special corner frame for flush mounted optics on hinge side. High-quality multi-chamber sealing profile adjustable fixed in the three sided groove.

**Hinges:** Concealed hinge system adjustable in three dimensions.

**Door Closer:** Invisible cam-action door closer system in accordance with DIN EN 1154 integrated in frame and door leaf.

**Surface:** Door leaf and frame galvanized and primed with one component primer similar RAL 7001.

**Mounting:** Delivery and professional assembly including filling of the cavities in the frame with mortar of group III.

**Special Models**

**Standard Glazing:** Regular glazing – or insulated glazing P6B held by steel glass bars. Minimum frieze width 125 mm on side and top, base 300 mm

**Ventilation Grille:** Burglar proof poke protected ventilation grille inside with galvanized bird screen 10 x 10 mm

**Top Panel or Top Light:** Top panel built as tested door leaf top light with burglar proof fixed glazing

**Sound Insulation:** Up to  $R_{w,p}$  46 dB

**Bullet Proof:** FB 4-NS or FB6-NS special inlay in door leaf and frame.

**Airtight:** High-quality multi-chamber sealing profile adjustable fixed in the three sided groove of the frame in connection with a drop seal or a stop seal.

**Driving Rain Water tight:** High-quality multi-chamber sealing profile adjustable fixed in the three sided groove of the frame in connection with a drop seal or a stop seal.

**Windproof** High-quality multi-chamber sealing profile adjustable fixed in the three sided groove of the frame in connection with a drop seal or a stop seal

**Stainless Steel:** Material 1.4301 (V2A) or 1.4571 (V4A), Surface bright mill, brushed or mattet.

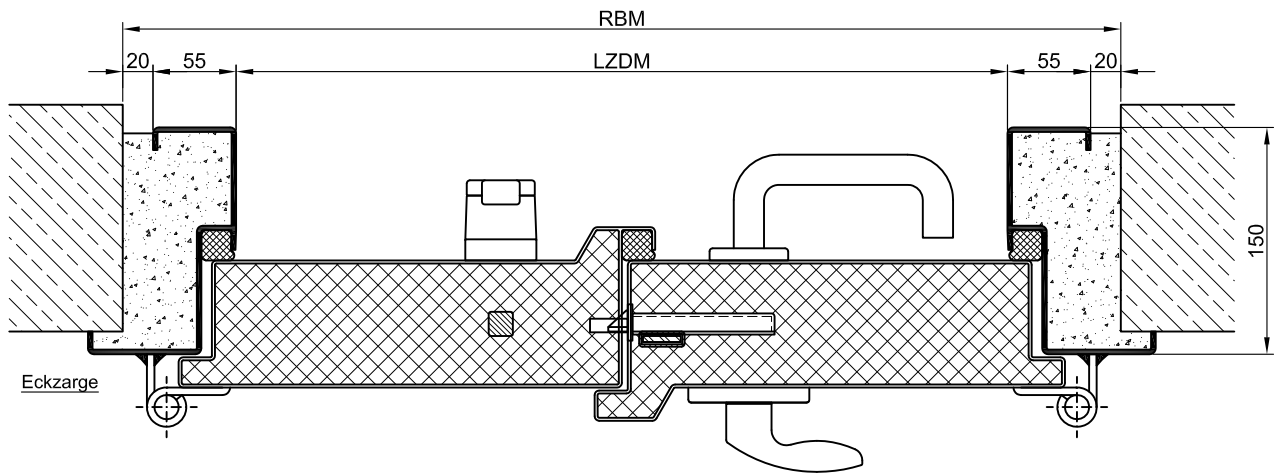

**BASIC**

**PREMIUM**

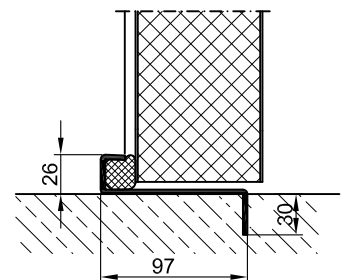
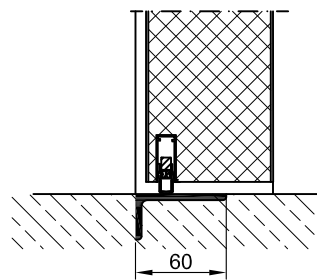
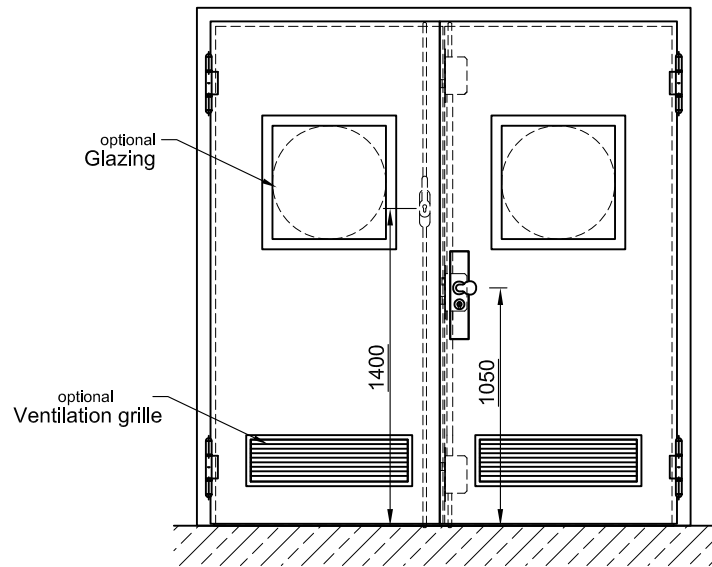
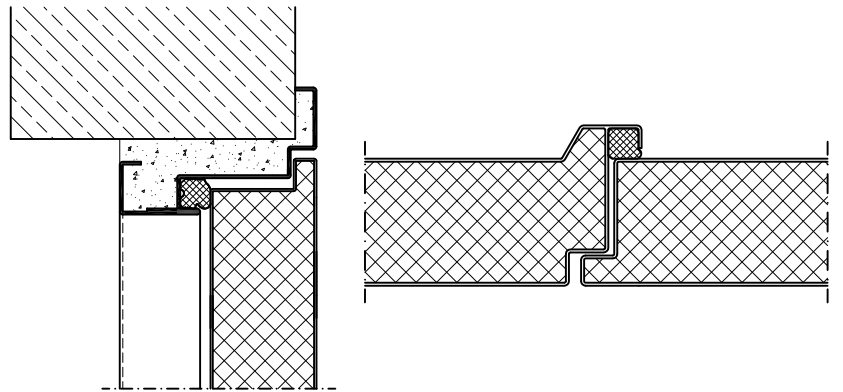
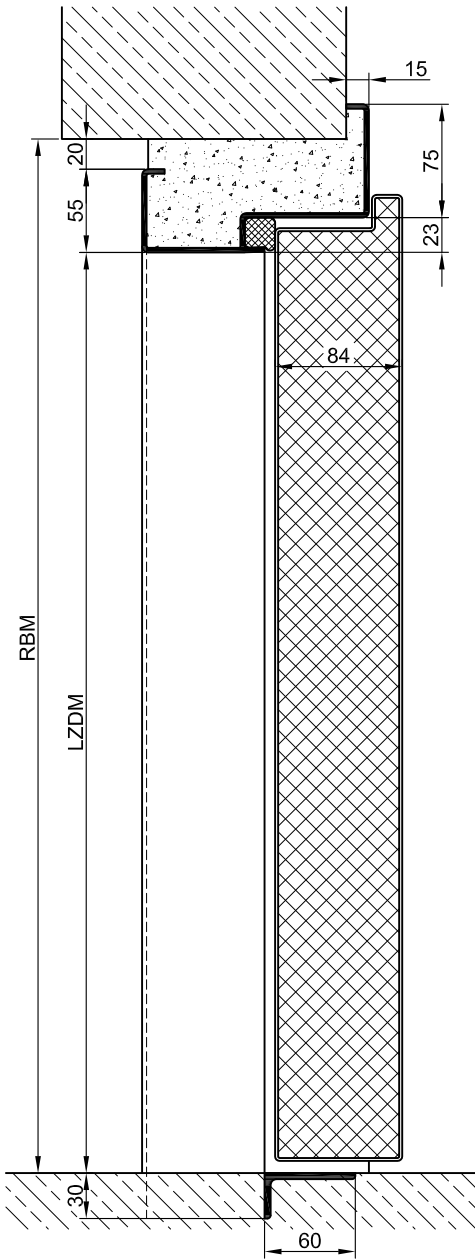

Separation rail

Countersunk floor seal

Stop sill

**BASIC**

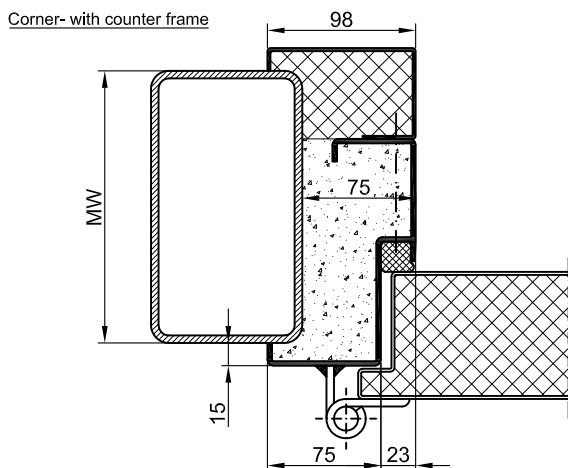
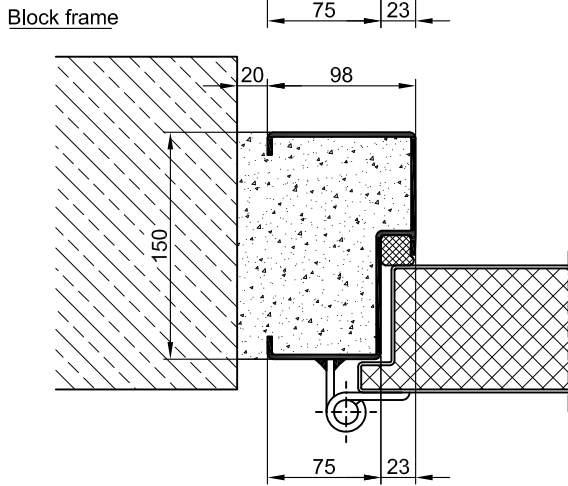
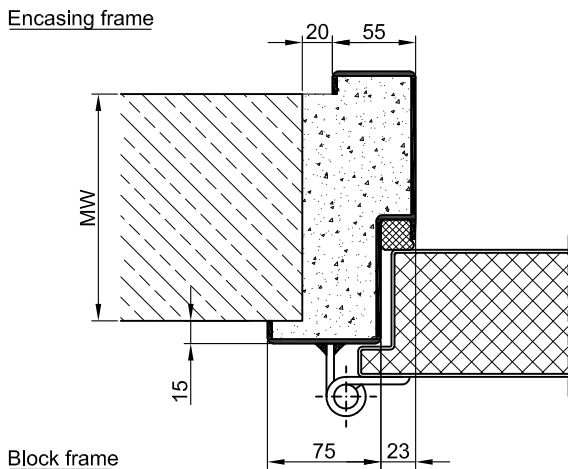
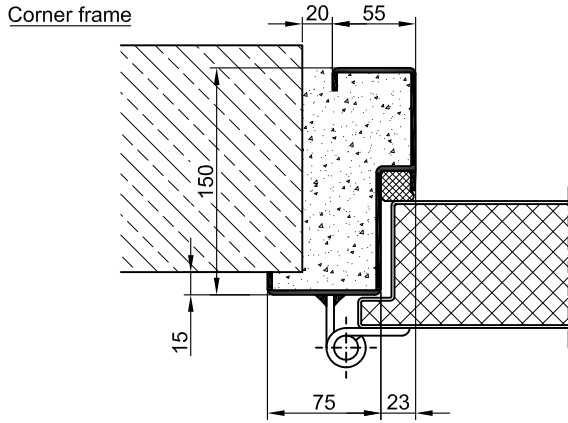

**PREMIUM**

